



U.S. Department of Justice

Federal Bureau of Investigation

Washington, D.C. 20535

MS MARY HELEN WASHINGTON

June 27, 2005



Subject: BROWN, LLOYD LOUIS

FOIPA No. 1014017- 000 /190-

Dear Ms. Washington:

The enclosed documents were reviewed under the Freedom of Information/Privacy Acts (FOIPA), Title 5, United States Code, Section 552/552a. Deletions have been made to protect information which is exempt from disclosure, with the appropriate exemptions noted on the page next to the excision. In addition, a deleted page information sheet was inserted in the file to indicate where pages were withheld entirely. The exemptions used to withhold information are marked below and explained on the enclosed Form OPCA-16a:

Section 552		Section 552a
<input checked="" type="checkbox"/> (b)(1)	<input type="checkbox"/> (b)(7)(A)	<input type="checkbox"/> (d)(5)
<input checked="" type="checkbox"/> (b)(2)	<input type="checkbox"/> (b)(7)(B)	<input type="checkbox"/> (j)(2)
<input type="checkbox"/> (b)(3) _____	<input checked="" type="checkbox"/> (b)(7)(C)	<input type="checkbox"/> (k)(1)
_____	<input checked="" type="checkbox"/> (b)(7)(D)	<input type="checkbox"/> (k)(2)
_____	<input type="checkbox"/> (b)(7)(E)	<input type="checkbox"/> (k)(3)
_____	<input type="checkbox"/> (b)(7)(F)	<input type="checkbox"/> (k)(4)
<input type="checkbox"/> (b)(4)	<input type="checkbox"/> (b)(8)	<input type="checkbox"/> (k)(5)
<input type="checkbox"/> (b)(5)	<input type="checkbox"/> (b)(9)	<input type="checkbox"/> (k)(6)
<input type="checkbox"/> (b)(6)		<input type="checkbox"/> (k)(7)

379 pre-processed pages are enclosed. To expedite requests, pre-processed packages are released the same way they were originally processed. Documents or information originating with other Government agencies were not referred to those agencies as part of this release.

You have the right to appeal any denials. Appeals should be directed in writing to the Co-Director, Office of Information and Privacy, U.S. Department of Justice, Flag Building, Suite 570, Washington, D.C. 20530-0001 within sixty days from receipt of this letter. The envelope and the letter should be clearly marked "Freedom of Information Appeal" or "Information Appeal." Please cite the FOIPA number assigned to your request that it may be easily identified.

The enclosed material is from the main investigative file(s) in which the subject(s) of your request was the focus of the investigation. Our search located additional references, in files relating to other individuals, or matters, which may or may not be about your subject(s). Our experience is, when ident, references usually contain information similar to the information processed in the main file(s). Because of our significant backlog, we have given priority to processing only the main investigative file(s). If you want the references, you must submit a separate request for them in writing and they will be reviewed at a later date, as time and resources permit,

See additional information which follows.

Sincerely yours,

A handwritten signature in black ink, appearing to read "D Hardy", with a stylized flourish at the end.

David M. Hardy
Section Chief,
Record/Information
Dissemination Section
Records Management Division

FEDERAL BUREAU OF INVESTIGATION

b7C

Form No. 1
THIS CASE ORIGINATED AT **PITTSBURGH, PENNSYLVANIA**

FILE NO. **100-672**

REPORT MADE AT PITTSBURGH, PA.	DATE WHEN MADE 12/6/41	PERIOD FOR WHICH MADE 11/6/41	REPORT MADE BY <div style="border: 1px solid black; height: 15px; width: 100%;"></div>
TITLE LLOYD LOUIS BROWN			CHARACTER OF CASE INTERNAL SECURITY - C

SYNOPSIS OF FACTS:

Subject arrested 1/21/37, Pittsburgh, Pa. on vagrancy and traffic violation. Sentenced to 10 days in jail on traffic violation. Subject indicted 7/5/40 on conspiracy and perjury with regard to circulating Communist petition.

ALL INFORMATION CONTAINED
HEREIN IS UNCLASSIFIED
DATE **5/23/03** BY **SP-10/BJD**

received 2/19/41 containing little information.

b7D

received from Philadelphia Office set out. Subject presently residing at 3047 Centre Avenue, Pittsburgh, Pa. Subject being considered for Custodial Detention memorandum. (u)

- P -

DETAILS:

Connection with obtaining signatures on a Communist petition under false pretenses. (u)

AT PITTSBURGH, PENNSYLVANIA

The Pittsburgh Office is in possession of a notification from the Allegheny County Bureau of Detectives, Identification Division, on February 19, 1941 to the effect that **LLOYD BROWN** was arrested January 21, 1937 on a charge of vagrancy and traffic violation. Discharged on the vagrancy charge and sentenced to 10 days in jail on traffic violation. On January 29, 1941 (u)

APPROVED AND FORWARDED: <i>J. E. Thornt...</i> SPECIAL AGENT IN CHARGE	DO NOT WRITE IN THESE SPACES
COPIES DESTROYED	100-57876
COPIES OF THIS REPORT 5 - Bureau 2 - New York 3 - Pittsburgh JAN 9 1942 100-82 12-1 (vH)	[Redacted]

b7C

b7D

this Office requested [redacted]

[redacted] was received by this Office on February 19, 1941 and the following information was revealed: (u)

[redacted]

(u)

(u)

On April 14, 1941 this Office received a letter from the Philadelphia Office attaching [redacted]

[redacted]

(u)

u

(u)

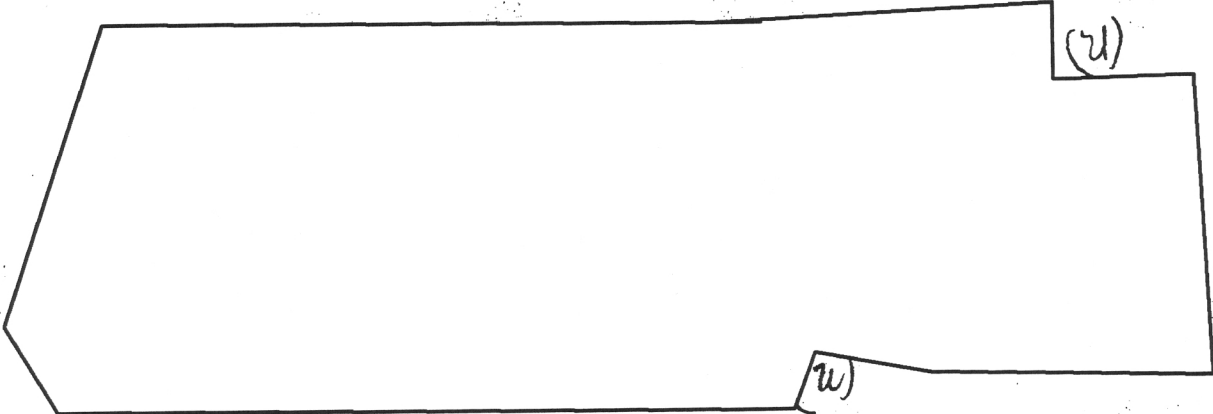

b7D

On July 1, 1941, a memorandum submitted by Special Agent [redacted] Pittsburgh, reveals the following information: (u)

b7C

LLOYD BROWN, District Organizer of Western Pennsylvania, is a veteran of the Y.C.L. In August, when the steel drive began, Subject went down to Pittsburgh as the representative of the National Committee of the League. Subject has been in the Y.C.L. longer than any other Negro member. He joined in 1929, in his native town of St. Paul, Minnesota, worked in New Haven, Youngstown, Cleveland, and New York; was also the first district organizer of New Jersey and one of a long list of editors of the "Young Worker". (u)

*1/6 Post
Memorandum to
[unclear]
500-127*

Subject has left many good friends in the various places in which he has worked. His favorite pastime is dancing, and it is rumored that he can "shake a mean hoof" on the dance floor, lays claim to be a shark at shooting pool, a claim hotly disputed in many and diverse quarters, proudest possession is the watch the New York Y.C.L. presented him as a farewell gift. (u)

The above information appeared in an article in the Year Book of the Young Communist League of America for the year 1937. (u)

*GASOT →
M.
VSE*

In a letter from the Bureau to Assistant Director E. J. CONNELLEY, dated August 21, 1941, there reads as follows:

"For your information and investigative attention, the following are the known Officers of the Young Communist League: (u)

LLOYD BROWN - State Secretary,
Western Pennsylvania.

On November 6, 1941, the Writer contacted the residence at 3047 Centre Avenue. It was noted that the name "BROWN" appeared on the front door as being in Flat #1. At that time, the Writer could not get any response to Mr. BROWN's doorbell. It was noted that there was also the name of [redacted] in [redacted]. The Writer rang this bell and a colored man came to the door who stated that his name was [redacted]. The Writer asked [redacted] if BROWN lived there. [redacted] stated that BROWN did live [redacted] and then the Writer asked [redacted] if BROWN was employed by the National Youth Administration. To this question, [redacted] stated, "Yes, BROWN is a Communist". The Writer then endeavored to question [redacted] further in regard to the statement that BROWN was a Communist, and [redacted] stated that he was sorry that he said that because he did not like to go into a man's political party. As the Writer was leaving this residence, he noticed that a colored man, in company with a colored woman and a small child, were coming up the steps and [redacted] the description of LLOYD LOUIS BROWN. (u)

From this investigation, it is reasonable to believe that LLOYD LOUIS BROWN is presently residing at 3047 Centre Avenue, Pittsburgh, Pa. (u)

This case is left in a pending status due to the fact that this Subject is now being considered for a Custodial Detention memorandum. (u)

- P E N D I N G -

OFFICE OF THE ATTORNEY GENERAL

WASHINGTON, D. C.

July 16, 1943

#916290 5/23/03
ALL FBI INFORMATION CONTAINED
HEREIN IS UNCLASSIFIED
DATE 7/23/03 BY SP2NCR/BK

MEMORANDUM FOR
HUGH B. COX, ASSISTANT ATTORNEY GENERAL
AND
J. EDGAR HOOVER, DIRECTOR
FEDERAL BUREAU OF INVESTIGATION

I refer to [redacted] memorandum to me dated June 28, 1943, which reviews the history, development, and meaning of the Special Case work and of the danger classifications that were made as a part of that work. b7C

After full re-consideration of these individual danger classifications, I am satisfied that they serve no useful purpose. The detention of alien enemies is being dealt with under the procedures established by the Alien Enemy Control Unit. The Special Case procedure has been found to be valueless and is not used in that connection. There is no statutory authorization or other present justification for keeping a "custodial detention" list of citizens. The Department fulfills its proper functions by investigating the activities of persons who may have violated the law. It is not aided in this work by classifying persons as to dangerousness.

Apart from these general considerations, it is now clear to me that this classification system is inherently unreliable. The evidence used for the purpose of making the classifications was inadequate; the standards applied to the evidence for the purpose of making the classifications were defective; and finally, the notion that it is possible to make a valid determination as to how dangerous a person is in the abstract and without reference to time, environment, and other relevant circumstances, is impractical, unwise, and dangerous.

For the foregoing reasons I am satisfied that the adoption of this classification system was a mistake that should be rectified for the future. Accordingly, I direct that the classifications heretofore made should not be regarded as classifications of dangerousness or as a

100-12370

308
57 AUG 14 1943

100-57876

determination of fact in any sense. In the future, they should not be used for any purpose whatsoever. Questions raised as to the status or activities of a particular person should be disposed of by consideration of all available information, but without reference to any classification heretofore made.

A copy of this memorandum should be placed in the file of each person who has hitherto been given a classification. In addition, each card upon which a classification appears should be stamped with the following language: || ✓

"THIS CLASSIFICATION IS UNRELIABLE. IT IS
HEREBY CANCELLED, AND SHOULD NOT BE USED
AS A DETERMINATION OF DANGEROUSNESS OR OF
ANY OTHER FACT. (SEE MEMORANDUM OF JULY 16,
1943 FROM THE ATTORNEY GENERAL TO HUGH B.
COX AND J. EDGAR HOOVER)."

Attorney General

~~100-57876~~
DC DM

February 20, 1941

LLOYD BROWN

Special Agent in Charge
Pittsburgh, Pennsylvania

Re: L. L. BROWN;
INTERNAL SECURITY - R

Dear Sir:

Reference is made to your letter of July 15, 1940, in which you recommend that L. L. Brown be considered for custodial detention in the event of a national emergency. (u)

It is desired that investigation be initiated to determine the present address and citizenship status of L. L. Brown. This investigation, if desired, may be accomplished through a local law enforcement organization and should be executed in line with the existing instructions on internal security matters. (u)

Very truly yours,

John Edgar Hoover
Director

ALL INFORMATION CONTAINED
HEREIN IS UNCLASSIFIED
DATE 5/23/03 BY SP2MTR/RBR

- Mr. Tolson _____
- Mr. E. A. Tamm _____
- Mr. Clegg _____
- Mr. Foxworth _____
- Mr. Nathan _____
- Mr. Ladd _____
- Mr. Glavin _____
- Mr. Nichols _____
- Mr. Hendon _____
- Mr. Rosen _____
- Mr. Tracy _____
- Miss Gandy _____

RECORDED & INDEXED

100-57876-X

COMMUNICATIONS SECTION
FEB 20 1941
P. M.
FEDERAL BUREAU OF INVESTIGATION
U. S. DEPARTMENT OF JUSTICE

FEB 24

CUSTODIAL
DETENTION
LIST
CROWN →
1943/

b7C
letter in file
file
letter file →

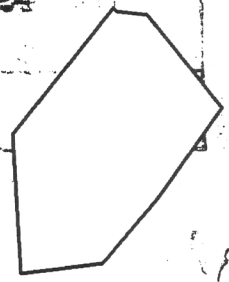

But
filed names

Handwritten notes on the left margin:
see index of Brown
Lloyd Brown

CUSTOMER
DETENTION
again
Gardner
before
Red
Nelson

I want to
extract him
→ index his
Army in 1942

Office Memorandum • UNITED STATES GOVERNMENT

TO : Director, FBI

DATE: March 22, 1950

FROM : SAC, New York

SUBJECT: LLOYD LOUIS BROWN, was.
SECURITY MATTER - C
Bufile 100-57876

for [unclear]
cc

SI CD UTD
3-31-50
lund
(u)

It is recommended that a Security Index Card be prepared on the above captioned individual.

X The Security Index Card on the captioned individual should be changed as follows: (Specify change only) *(u)*

NAME _____

ALIASES (ADD) LLOYD L. BROWN, L. L. BROWN

G.I.R.A.

RACE _____ SEX _____ NATIVE BORN _____ NATURALIZED _____ ALIEN _____

COMMUNIST _____ SOCIALIST WORKERS PARTY _____ INDEPENDENT SOCIALIST LEAGUE _____

MISCELLANEOUS (Specify) _____

TAB FOR DETCOM _____ TAB FOR COMSAB _____

DATE OF BIRTH _____ PLACE OF BIRTH _____

RESIDENCE ADDRESS _____

BUSINESS ADDRESS (Show name of employing concern and address) _____

Masses and Mainstream

832 Broadway, New York, N. Y. *(u)*

NATURE OF INDUSTRY OR BUSINESS (Specify from Strategic and Vital Industry List)

ALL INFORMATION CONTAINED
HEREIN IS UNCLASSIFIED
DATE *5/27/03* BY *60290/BCE/MC/BR* RECORDED - 53

RCM:mat
100-24616

125

50 APR 5 1950

100-57876-

MAR 23 1950

EX-87

FIVE

COMMUNIST

BROWN, LOYD L.

Alias: Brown, L. L.

3047 Center Street
Pittsburgh, Pa. 5/29/41

Is a member of the Pittsburgh District Committee of the Communist Party and was a speaker at a joint meeting of the Communist Party and the Young Communist League in [redacted] in Pittsburgh. (Confidential Informant, [redacted] Pittsburgh, Pa., 7/15/40; 100-2-021).

Member District Executive Committee of the Communist Party of Western Pennsylvania. Was a speaker for the Communist Party, sent out to Section Organizers for their use at Section Functions by the District Headquarters in 1938. (Conf. Inf. [redacted] Pittsburgh, Pa., 3/27/41; 100-16832-1). m.c. ✓

b2

b7D

ALL INFORMATION CONTAINED
HEREIN IS UNCLASSIFIED
DATE 5/23/03 BY 60220/BCE/MC/KBR

100-57876-14

FEDERAL BUREAU OF INVESTIGATION
U. S. DEPARTMENT OF JUSTICE

UNITED STATES GOVERNMENT

Memorandum

CONFIDENTIAL

TO : DIRECTOR, FBI (100-3-99) *100-3-99*
ATT: ASSISTANT DIRECTOR A. H. BELMONT (u) X

DATE:

7/8/60

FROM : SAC, NEW YORK (100-24616) (u)

SUBJECT: [COMMUNIST PARTY, USA
TOPLEV
INTERNAL SECURITY - C]

LLOYD LOUIS BROWN
SECURITY MATTER - C
(OO:NY)

CLASS. & EXT. BY *0283/ET/AG*
REASON - FCIM II, 1-2.4.2
DATE OF REVIEW *6-26-91*

DECLASSIFIED BY *60290/BCE/MCA/KBE*
ON *6/20/03*

On 7/1/60, in the vicinity of 43rd St., and Eighth Avenue, NYC, LLOYD BROWN was approached by SA [redacted] for the purpose of conducting an interview under outstanding instructions relating to the Toplev Program. SA [redacted] observed from a discreet distance.

b7C

When approached, BROWN acknowledge his identity and appeared somewhat startled when the identity of the interviewing Agent was revealed. Following a brief preliminary conversation BROWN relaxed and smiling broadly stated that he had no desire whatsoever to discuss any matter with the FBI. Further attempts to engage him in conversation, as he continued walking toward his place of employment, were unsuccessful. Because a light rain had started to fall it was suggested that he pause under a hotel marquee. BROWN refused. The interview was terminated. (u)

Although BROWN was not unfriendly or hostile he nevertheless gave no indication that he might cooperate with the Bureau. Therefore, no recontact is anticipated at this time. The results of this interview will be included in the next annual report. (u)

3-Bureau (100-3-99) (RM)
(1-100-57876) (u)
1-New York [redacted] (41)
1-New York 100-24616 (41) (u)

JM:ume
(5) b2
b7D

APPROPRIATE AGENCIES

DATE *6-27-78* classification *SECRET*

100-57776

Classified by *2032*
Exempt from GDS Category *2*
Date of Declassification Indefinite
6/14/78 *dos/gbw*

16 JUL 12 1960

INT. SEC. X

52 JUL 19 1960

CONFIDENTIAL

UNRECORDED COPY FILED IN

APPROPRIATE AGENCIES AND FIELD OFFICES ADVISED BY ROUTING SLIP (S) OF DATE

APPROPRIATE AGENCIES AND FIELD OFFICES ADVISED BY ROUTING SLIP (S) OF DATE

Handwritten notes and signatures on the right margin.

b2
b7D

HR:vea

December 9, 1941

~~CONFIDENTIAL~~
REGISTERED MAIL
RETURN RECEIPT REQUESTED

Special Agent in Charge
Pittsburgh, Pennsylvania

RE: LOYD L. BROWN, wa;
INTERNAL SECURITY

Dear Sir:

There is enclosed herewith a photostatic copy of

— an addition to the Custodial Detention card relating to Subject. This addition is to be attached to the photostatic copy of the Custodial Detention card already in your possession.

X — a revised Custodial Detention card relating to Subject to be substituted for the photostatic copy of the Custodial Detention card presently in your possession which should be destroyed. (U)

Very truly yours,

J. E. Hoover

John Edgar Hoover
Director

#976290 5/23/03
DECLASSIFIED BY SP3MUR/RBR
ON 5/23/03

- Mr. Tolson _____
- Mr. E. A. Tamm _____
- Mr. Clegg _____
- Mr. Glavin _____
- Mr. Ladd _____
- Mr. Nichols _____
- Mr. Tracy _____
- Mr. Rosen _____
- Mr. Carson _____
- Mr. Coffey _____
- Mr. Hendon _____
- Mr. Holloman _____
- Mr. Quinn Tamm _____
- Mr. Nease _____
- Miss Gandy _____

Enclosure

RECORDED

100-57876-1X
FEDERAL BUREAU OF INVESTIGATION
DEC 11 1941
U. S. DEPARTMENT OF JUSTICE

DEC 11 1941

100-12370
LJM:vea

June 24, 1941

Special Agent in Charge
Pittsburgh, Pennsylvania

RE: L. L. BROWN
INTERNAL SECURITY - R

Dear Sir:

The Bureau desires that it be advised as to
the exact status of this case at the present time. *u*

Very truly yours,

J. E. Hoover

John Edgar Hoover
Director

*permanently
Closed!*

#976290 5/23/03
ALL INFORMATION CONTAINED
HEREIN IS UNCLASSIFIED
DATE 5/23/03 BY SP2MJK/BR

RECORDED

100-57876-X
FEDERAL BUREAU OF INVESTIGATION
JUN 25 1941
U.S. DEPARTMENT OF JUSTICE

- Mr. Tolson _____
- Mr. E. A. Tamm _____
- Mr. Clegg _____
- Mr. Foxworth _____
- Mr. Glavin _____
- Mr. Ladd _____
- Mr. Nichols _____
- Mr. Rosen _____
- Mr. Carson _____
- Mr. Drayton _____
- Mr. Quinn Tamm _____
- Mr. Hendon _____
- Mr. Tracy _____
- Miss Gandy _____

COMMUNICATIONS SECTION
MAILED
★ JUN 24 1941
P. M.
FEDERAL BUREAU OF INVESTIGATION
U. S. DEPARTMENT OF JUSTICE

RTE *JEM*

Federal Bureau of Investigation

U. S. Department of Justice

Pittsburgh, Pennsylvania
July 22, 1941

Director
Federal Bureau of Investigation
Washington, D. C.

Re: L. L. BROWN
INTERNAL SECURITY
Bureau file #100-12370

Dear Sir:

Reference is made to Bureau letter of June 24, 1941, requesting to be advised of the exact status of this case. Please be informed that the correct present address of this individual has not as yet been ascertained. Efforts are being made to obtain this information through confidential informants and other sources of information and immediately upon receipt of this information the matter will be given investigative attention and a report will be forwarded to the Bureau. *u*

Very truly yours,

J. E. Thornton
J. E. Thornton *TH*
Special Agent in Charge

CMK:SJA
100-672

#976290 5/23/63
ALL INFORMATION CONTAINED
HEREIN IS UNCLASSIFIED
DATE 5/23/63 BY SPANIKER

RECORDED

mlr

100-57876-X2

FEDERAL BUREAU OF INVESTIGATION
5 JUL 23 1941
U. S. DEPARTMENT OF JUSTICE

TH *SP*

128

LJM:EVM
100-12370

October 30, 1941

ALL INFORMATION CONTAINED
HEREIN IS UNCLASSIFIED
DATE 5/23/03 BY 60290/BCE/MCT/KBR

Special Agent in Charge
Pittsburgh, Pennsylvania

RE: L. L. BROWN
INTERNAL SECURITY (R)

Dear Sir:

Reference is made to your letter dated July 22, 1941, in which you advised that the correct present address of the above captioned subject has not as yet been ascertained. U

*How
faked!!*

Your attention is directed to your letter dated July 15, 1940, in which you recommended Brown for custodial detention, advising that he was a member of the Pittsburgh District Committee of the Communist Party. In view of the allegation concerning this subject's activities in the Communist Party, you are requested to take active steps to ascertain his present address in the event he has moved from the territory covered by your field division. His forwarding address should be obtained for the assistance of the office covering his present locality. It is possible your confidential informant may be able to furnish you some assistance in this matter. U

b2
b7D

Very truly yours,

John Edgar Hoover
Director

- Mr. Tolson _____
- Mr. E. A. Tamm _____
- Mr. Clegg _____
- Mr. Glavin _____
- Mr. Ladd _____
- Mr. Nichols _____
- Mr. Tracy _____
- Mr. Rosen _____
- Mr. Carson _____
- Mr. Coffey _____
- Mr. Hendon _____
- Mr. Holloman _____
- Mr. Quinn Tamm _____
- Mr. Nease _____
- Miss Gandy _____

177
COMMUNICATIONS SECTION
MAILED
★ OCT 30 1941 ★
P. M.
FEDERAL BUREAU OF INVESTIGATION
U. S. DEPARTMENT OF JUSTICE

RECORDED

100-57876-43

FEDERAL BUREAU OF INVESTIGATION
U. S. DEPARTMENT OF JUSTICE

HR:vr1

December 5, 1941

b7C

ALL INFORMATION CONTAINED
HEREIN IS UNCLASSIFIED
DATE 5/23/03 BY SP5MJK/BJR

MEMORANDUM FOR [REDACTED]
CHIEF, SPECIAL DEFENSE UNIT

BLEP

There is transmitted herewith a dossier showing the information presently available in the files of this Bureau with respect to Loyd L. Brown, with alias whose address is 3047 Center Street, Pittsburgh, Pa. (u).

It is recommended that this individual be considered for custodial detention in the event of a national emergency. The information contained on the attached dossier constitutes the basis for appropriate consideration in this regard. (u)

It should be understood, of course, that additional information may be received from time to time supplementing that already available in the Bureau's files, and as such data are received they will be made available to you so that the dossier in your possession may be supplemented thereby. (u)

It will be greatly appreciated if you will advise this Bureau at your earliest convenience as to the decision reached in this case. (u)

Very truly yours,

J. E. Hoover

COMMUNICATIONS SECTION
RECEIVED
DEC 5 1941
Enclosure
FEDERAL BUREAU OF INVESTIGATION
U. S. DEPARTMENT OF JUSTICE

RECORDED
John Edgar Hoover
Director

100-57876-1152
FEDERAL BUREAU OF INVESTIGATION
DEC 12 1941
U. S. DEPARTMENT OF JUSTICE

Federal Bureau of Investigation,
United States Department of Justice
Pittsburgh, Pennsylvania
January 14, 1942

g
A

Director
Federal Bureau of Investigation
Washington, D. C.

Re: Custodial Detention data on
LLOYD LOUIS BROWN

Dear Sir:

Enclosed please find a memorandum on the above individual who has been recommended by this office for custodial detention. (u)

Very truly yours,

J. E. Thornton
J. E. THORNTON
Special Agent in Charge

JET:JIM
Encl.

ALL INFORMATION CONTAINED
HEREIN IS UNCLASSIFIED
DATE 5/23/03 BY SPAMC/BR

COPIES DESTROYED 11/4/58 R411

ORIGINAL FILE

I ENCL. 19
g
mca
H

RECORDED
10 FEB 4 1942

100-57876-2
FEDERAL BUREAU OF INVESTIGATION
19 JAN 15 1942
U. S. DEPARTMENT OF JUSTICE
FIVE JMN

EX-18

Re: LLOYD LOUIS BROWN
(Negro)

ADDRESS: 3047 Center Avenue, Pittsburgh, Pennsylvania
(As of 11-6-41) (u)

COMMUNIST

CITIZENSHIP

[REDACTED]
Pittsburgh file 100-672.(u)

[REDACTED]
Pittsburgh file 100-672.(u)

b7D

[REDACTED]
Pittsburgh file 100-672.(u)

BROWN indicted and tried in the Allegheny County Courts on election frauds in circulation of Communist election petitions.
(Pittsburgh file 100-672) 7-8-40 (u)

b2
b7D

[REDACTED] and [REDACTED] advise L. L. BROWN is a member of the Communist Party and is active in the Young Communist League.
(Pittsburgh file 100-672) 2-26-41. (u)

Listed as a known officer of the Young Communist League, as State Secretary of Western Pennsylvania on National Committee.
(Letter from the Bureau to the New York Office, dated 8-21-41)
Pittsburgh file 100-672.(u)

Subject referred to as the District organizer of Western Pennsylvania in an article which appeared in the Year Book of the Young Communist League for the year of 1937.
(Memorandum to the Special Agent in Charge by Special Agent [REDACTED]
Pittsburgh file 100-672. 7-1-41 (u)

b7C

Picture in the Pittsburgh file 100-672(u)

COPIES DESTROYED 10-5-71

100-57-76-



THE DIRECTOR OF CIVILIAN DEFENSE
WASHINGTON

March 27, 1942

Mr. John Edgar Hoover
Director
Federal Bureau of Investigation
U. S. Department of Justice
Washington, D.C.

Dear Mr. Hoover:

I am forwarding copies of your letters with respect to the following persons to the Regional Offices for distribution to State Defense Councils and the furnishing of a report:

[Redacted]

Lloyd Louis Brown

[Redacted]

*E. J. ...
L. M. ...*

E. J. ...

b7C

I am establishing files with respect to the persons listed below and would appreciate your forwarding to me at your early convenience such additional information as may be obtained by you with respect to them.

[Redacted]

*RE Lanter
JFC
R. A.
JFC
E. J. ...*

Sincerely yours,

James M. Landis
Director

J. D.

FEDERAL BUREAU OF INVESTIGATION

Form No. 1

THIS CASE ORIGINATED AT **PITTSBURGH, PA.**

FILE NO. **100-672**

REPORT MADE AT PITTSBURGH, PA.	DATE WHEN MADE 4/20/42	PERIOD FOR WHICH MADE 4/8/42	REPORT MADE BY <div style="border: 1px solid black; height: 15px; width: 100%;"></div>
TITLE LLOYD LOUIS BROWN			CHARACTER OF CASE INTERNAL SECURITY-C

SYNOPSIS OF FACTS: Subject still residing at 3047 Center Avenue, Pittsburgh, Pa., telephone, Schenley 5715. (u)

-P-

REFERENCES: Report of Special Agent dated 12/6/41, at Pittsburgh, Pa. (u)

Letter to the Bureau dated 1/14/42. (u)

b7C

DETAILS: AT PITTSBURGH, PA.

On April 8, 1942, the writer contacted the residence at 3047 Center Avenue and personally observed the name of BROWN on a card indicating that BROWN lived in the upstairs flat. On the same date the writer requested the telephone number of LLOYD LOUIS BROWN at 3047 Center Avenue and was advised by the Telephone Company, that the phone was listed phone Schenley 5715 (u)

ALL INFORMATION CONTAINED
HEREIN IS UNCLASSIFIED
DATE 5/23/03 BY SP2 MJK/BR

APPROVED AND FORWARDED: <i>J. E. Thornton</i> SPECIAL AGENT IN CHARGE	DO NOT WRITE IN THESE SPACES
COPIES OF THIS REPORT 5-Bureau 3-Pgh. <div style="border: 1px solid black; display: inline-block; width: 100px; height: 15px;"></div> u	100-672-1874-4 APR 23 1942 b7C
COPY IN	RECORDED & INDEXED

COPIES DESTROYED 1/15/58

UNDEVELOPED LEADS

THE PITTSBURGH FIELD DIVISION

AT PITTSBURGH, PA.

Will make a periodical check on LLOYD LOUIS BROWN insofar as his local residence is concerned. (u)

Tom V. [signature]

--PENDING--

FEDERAL BUREAU OF INVESTIGATION

Form No. 1

THIS CASE ORIGINATED AT **PITTSBURGH, PENNSYLVANIA**

FILE NO. 100-672

REPORT MADE AT PITTSBURGH, PA.	DATE WHEN MADE 7-16-42	PERIOD FOR WHICH MADE 7-10-42	REPORT MADE BY [Redacted] b7C
TITLE LLOYD LOUIS BROWN			CHARACTER OF CASE INTERNAL SECURITY - C CUSTODIAL DETENTION

SYNOPSIS OF FACTS:

Subject still residing at 3047 Center Avenue, Pittsburgh, Pa., telephone Schenley 5715. (u)

- P -

REFERENCE:

Report of Special Agent [Redacted] dated at Pittsburgh, Pa. 4-20-42. (u)

DETAILS:

AT PITTSBURGH, PENNSYLVANIA

b7C

On interview at 3047 Center Avenue, [Redacted] at that address, advised that subject and his wife were presently residing at that address. [Redacted] Pittsburgh Division, Bell Telephone Company of Pennsylvania, stated that there was a telephone listed at 3047 Center Avenue, [Redacted] telephone number Schenley 5715. (u)

ALL INFORMATION CONTAINED
HEREIN IS UNCLASSIFIED
DATE **5/23/03** BY **SP2 MTK/R**

- P E N D I N G -

b7C

1442 R/R
3-15-42

APPROVED AND FORWARDED: <i>J. C. Shornton</i> SPECIAL AGENT IN CHARGE	DO NOT WRITE IN THESE SPACES	
COPIES DESTROYED 1/5/84	7876	INDEXED
COPIES OF THIS REPORT 5 - Bureau 2 - Pittsburgh HGH	4 JUL 18 1942	

UNDEVELOPED LEADS

THE PITTSBURGH FIELD DIVISION

AT PITTSBURGH, PA.

Will make a periodic check on LLOYD LOUIS BROWN insofar as his local residence is concerned. (U)

FEDERAL BUREAU OF INVESTIGATION

Form No. 1

THIS CASE ORIGINATED AT **PITTSBURGH, PENNSYLVANIA**

FILE NO. **100-672**

REPORT MADE AT PITTSBURGH, PA.	DATE WHEN MADE 10-9-42	PERIOD FOR WHICH MADE 9-12, 23-42	REPORT MADE BY <div style="border: 1px solid black; width: 100px; height: 20px;"></div>
TITLE CHANGED LLOYD LOUIS BROWN, with alias Lloyd Louis Dight			CHARACTER OF CASE INTERNAL SECURITY - C CUSTODIAL DETENTION

SYNOPSIS OF FACTS:

Subject inducted into U. S. Army 8-25-42; serial #33287993. Activities of subject in the Communist party detailed. Criminal record set forth. Physical description set out. (U)

ALL INFORMATION CONTAINED
HEREIN IS UNCLASSIFIED
DATE **7/20/03** BY **SP8MTR/BJR**

- C -

REFERENCE: Report of Special Agent dated at Pittsburgh, Pennsylvania, July 16, 1942. (U)

DETAILS: AT PITTSBURGH, PENNSYLVANIA

The title of this case is being changed to reflect the addition of an alias of the subject, LLOYD LOUIS DIGHT. (U)

According to the records of Local Board No. 5, Herron Hill High School, 3800 Center Avenue, as produced by Chief Clerk, subject was inducted into the United States Army on August 25, 1942. The Selective Service file indicates that his Army serial number is 33287993. The subject stated, in a questionnaire filed with the Board on June 17, 1941, that he had also been known as LLOYD LOUIS DIGHT. (U)

On April 14, 1941, the Pittsburgh Field Division received



APPROVED AND FORWARDED: <i>J. E. Thornton</i> SPECIAL AGENT IN CHARGE	DO NOT WRITE IN THESE SPACES 100-57871-6 9 OCT 13 1942 b7C
COPIES OF THIS REPORT 1 Bureau 1 G-2 Pittsburgh 2 Pittsburgh	RECORDED & INDEXED

Summary to G-2, 100-57871-6 (U)

COPY IN FILE

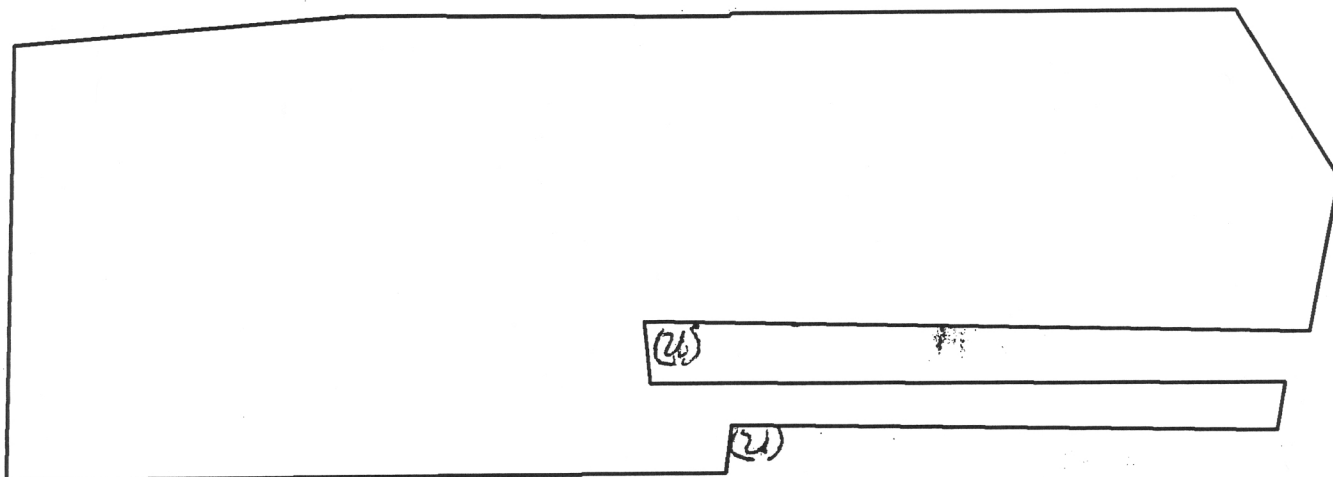
b2
b7D

Subject's first known association with the Communist party, according to the files of the Pittsburgh Field Division is a notation in confidential source No. [] quoting an article in the "Daily Worker" on October 3, 1933, wherein describing an anti-war Congress held by the Communist party in St. Nicholas Arena, New York City, there is as follows: (u)

"Lloyd Brown of the Young Communist League electrified the nearly 3000 delegates and 2000 spectators by his declaration that the militant youth of America will follow the path of the heroic Communist Party leader of youth, KARL LIEBKNECHT, in unyielding struggle against the war makers. BROWN was one of three youth speakers." (u)

In the 1937 yearbook of the Young Communist League, subject was listed as the district organizer for the Western District of Pennsylvania, and following is an article describing the subject in that periodical. (u)

"LLOYD BROWN, District Organizer of Western Pennsylvania, is a veteran Y.C.L. 'er. In August, when the steel drive began, LLOYD went down to Pittsburgh as the representative of the National Committee of the League. LLOYD has been in the YCL longer than any other Negro member. He joined in 1929, in his native town of St. Paul, Minnesota, worked in New Haven, Youngstown, Cleveland, and New York; was also the first district organizer of New Jersey and one of a long list of editors of the "Young Worker". (u)

"LLOYD has left many good friends in the various places in which he has worked. His favorite pastime is dancing and it is rumored that he can shake a mean hoof on the dance floor, lays claim to being a shark at shooting pool, a claim hotly disputed in many and divers quarters..proudest possession is the watch the New York Y.C.L.'ers presented him as a farewell gift."

(u)

According to confidential source of information No. [] the leaders of the Communist Party of Western Pennsylvania were in a group known as the "District Committee". Subject was a member of this committee in 1939. ^{March 1941} The source indicates that he previously had been a member of the Speaker's Committee since 1938. During this period, according to [] now in the files of the Pittsburgh office, which was found in []

4/4/56
WIM

b2
b7D

[]

(u)

b2
b7C
b7D

In a [] dated February 2, 1941, the subject is described as a figure in the party, and confidential informants [] and [] whose identify is known to the Bureau, advised that early in 1941, the subject was a member of the Communist Party. (u)

Prior to the election of 1940, the Communist nominating petition was circulated in the Pittsburgh area to secure the signatures necessary to place the party candidates on the ballot. According to the testimony at his trial, the subject in June, 1940, circulated petitions of the Communist party falsely reporting to prosperous figures that they were petitions of the Democratic Party. Because of this he was indicted in the June term of the Grand Jury, under indictment #519, charging conspiracy, and indictments #596 and #597 charging perjury. After the trial on August 30, 1940, the subject was found guilty, and after a motion for a new trial had been refused, on March 18, 1941, he was sentenced on each of the perjury charges, the sentence to run concurrently, to serve four months in Allegheny County Jail and to pay a fine of \$200 on the conspiracy charge. The subject served his term and paid his fine. (u)

In an article appearing in the Pittsburgh Sun Telegraph on April 21, 1941, the subject was described as instructing his seventeen fellow Communist party members, who were in the Allegheny County Jail with him, serving sentences which were similar to that of the subject, in American history and English. (u)

b7D

[]
[]
[] (u)

According to confidential informant [redacted] whose identity is known to the Bureau, on May 11, 1941 [redacted]

[redacted] In a letter from the Bureau to the New York Field Division dated August 21, 1941, the subject was listed as being the secretary for Western Pennsylvania, of the Young Communist League and a member of its national committee. On October 17, 1941 the subject was in the Communist Party Office, 305 7th Avenue, according to confidential informant [redacted] and [redacted] he attended a meeting held at [redacted] where he was observed by [redacted] (u)

According to confidential source of information No. [redacted] the subject attended a [redacted] conference of the leaders of the Communist Party of Western Pennsylvania, held at 1800 Center Avenue, on [redacted] where he was observed by [redacted] whose identity is known to the Bureau. On May 2, 1942, the same source indicates that he was present at the May Day celebration and party at Carnegie Hall, North Side, where he was observed by [redacted] On [redacted] he was at a meeting of the party held at 1800 Center Avenue and on July 4, 1942, he attended the July 4 picnic of the party held at Linden Grove, Castle Shannon, where he was observed by [redacted] (u)

According to the Identification Division of the Bureau, in a reported dated November 26, 1940, the following is the subject's criminal record. (u)

1-21-37 as Lloyd Brown, Pittsburgh, Pa., PD #33201; vagrancy and traffic violation; discharged on first count; ten days jail sentence on second count. (u)

Allegheny County Detective Bureau, Pittsburgh, Pa., as Lloyd Lewis Brown, PD #11908, 3-18-41; sentenced on charge for which he was convicted 8-30-40; four months Allegheny County Jail; \$200 fine. (u)

The following is a physical description of the subject.

Name	LLOYD LOUIS BROWN, with alias Lloyd Louis Dight
Race	Negro
Sex	Male
Born	March 3, 1913 at St. Paul, Minnesota (u)
Age	29
Height	5' 5"
Weight	152 lbs.
Build	Medium slender
Complexion	Light tan
Hair	Black

Eyes
Nationality
Residence
Relatives

Dark brown
American negro
3047 Center Avenue, Pittsburgh, Pa.

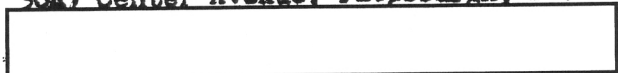

FBI Number

#2049998

b7C

Fingerprint classification 21 1 T 5

21 1 R 10

Scars and marks

None

In view of the fact that the subject is at present under the jurisdiction of the United States Army, this case is being closed. (u)

- C L O S E D -

SOURCES OF INFORMATION

b2
b7C

No. [] - the report of Special Agent [] in the Pittsburgh file 100-577-908, dated at Pittsburgh April 22, 1942, entitled "COMMUNIST PARTY OF THE U. S. A. (Pittsburgh, Pa., District #5)". (u)

No. [] - the report of Special Agent [] in the Pittsburgh file 100-577-57, dated at Pittsburgh March 27, 1941, entitled "THE COMMUNIST PARTY OF THE U. S. A. (Pittsburgh, Pa., District #5)". (u)

No. [] - the report of Special Agent [] in the Pittsburgh file 100-577-1067, dated at Pittsburgh June 30, 1942, entitled "COMMUNIST PARTY OF THE U. S. A. (Pittsburgh, Pa., District #5)". (u)

[] is Special Agent [] of the Pittsburgh Field Division. (u)

GEA:mr

100-5776

SAC, Pittsburgh

June 22, 1944

J. Edgar Hoover, Director - Federal Bureau of Investigation

LLOYD LOUIS BROWN, with alias
INTERNAL SECURITY - C

b7C

Reference is made to the closing report of Special Agent [redacted] dated October 9, 1942 at Pittsburgh, Pennsylvania in the above captioned matter. (U)

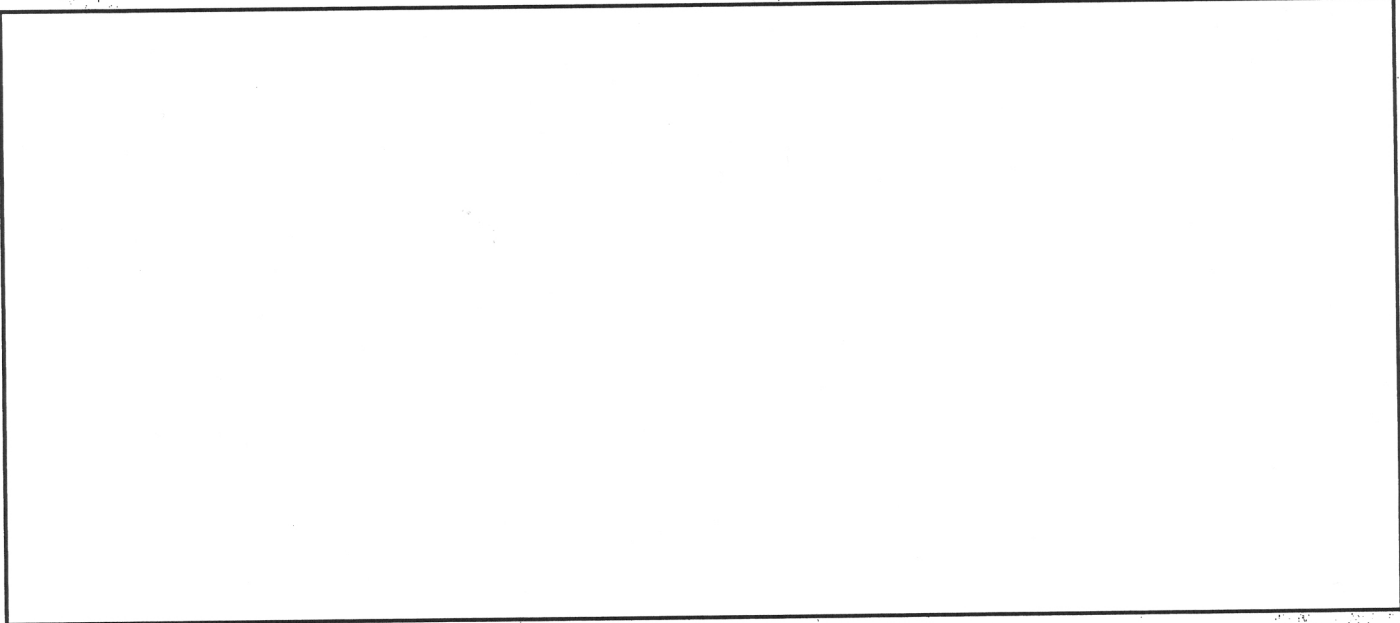

The above data are being furnished for your information and assistance. (U)

Referral/Direct

ALL INFORMATION CONTAINED
HEREIN IS UNCLASSIFIED
DATE 5/23/03 BY SP2MJK/BR

RECORDED

100-57876-7
FEDERAL BUREAU OF INVESTIGATION
JUN 24 1944
U. S. DEPARTMENT OF JUSTICE

COMMUNICATIONS SECTION
JUN 22 1944 P.M.
FEDERAL BUREAU OF INVESTIGATION
U. S. DEPARTMENT OF JUSTICE

- Mr. Tolson _____
- Mr. E. A. Tamm _____
- Mr. Clegg _____
- Mr. Coffey _____
- Mr. Glavin _____
- Mr. Ladd _____
- Mr. Nichols _____
- Mr. Rosen _____
- Mr. Tracy _____
- Mr. Mohr _____
- Mr. Carson _____
- Mr. Hendon _____
- Mr. Mumford _____
- Mr. Jones _____
- Mr. Quinn Tamm _____
- Mr. Nease _____

234
5/23/03

21

~~SPECIAL MESSENGER~~
~~CONFIDENTIAL~~

1976290 5/23/03
DECLASSIFIED BY SP2MOT/KBR
ON 5/23/03

To: Assistant Chief of Staff
G-2
War Department
Washington, D. C.

Date:

b7C

Attention: Colonel

From: J. Edgar Hoover - Director, Federal Bureau of Investigation

Subject: Lloyd Louis Brown, alias Lloyd Louis Dight

Referral/Direct

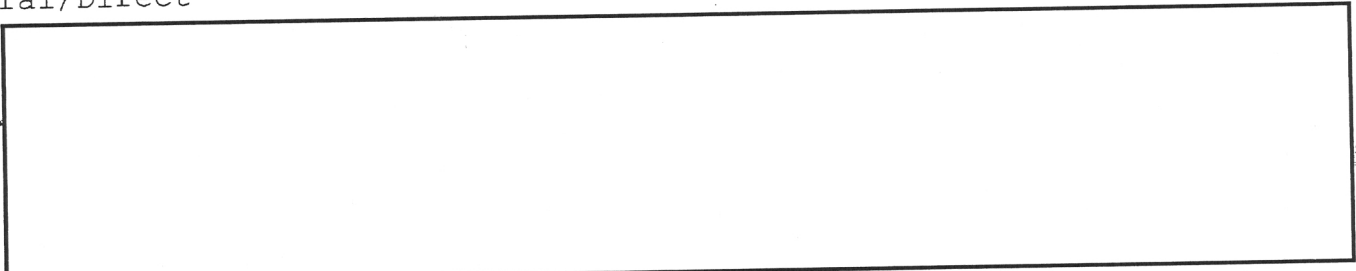

Lloyd Louis Brown, alias Lloyd Louis Dight, was inducted into the United States Army August 25, 1942, Army Serial Number 33287993. Information concerning his activities in the Communist Party have previously been received by your office. (u)

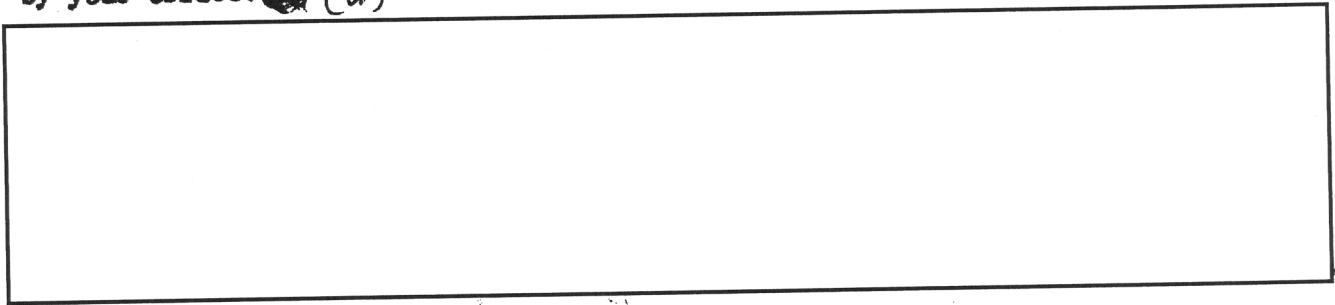

The above information is being forwarded for the completion of your files. (u)

- Mr. Tolson _____
- Mr. E. A. Tamm _____
- Mr. Clegg _____
- Mr. Coffey _____
- Mr. Glavin _____
- Mr. Ladd _____
- Mr. Nichols _____
- Mr. Rosen _____
- Mr. Tracy _____
- Mr. Mohr _____
- Mr. Carson _____
- Mr. Hendon _____
- Mr. Mumford _____
- Mr. Jones _____
- Mr. Quinn Tamm _____
- Mr. Nease _____
- Miss Gandy _____

100-57896-

RECORDED
&
INDEXED

100-57896-8
FEDERAL BUREAU OF INVESTIGATION
JUN 27 1944
U. S. DEPARTMENT OF JUSTICE

50 AUG 3 1944

Office Memorandum • UNITED STATES GOVERNMENT

TO : Director, FBI

DATE: January 4, 1946

FROM : SAC, Pittsburgh

SUBJECT: LLOYD LOUIS BROWN, wa
SECURITY MATTER - C
Bureau file 100-12370ALL INFORMATION CONTAINED
HEREIN IS UNCLASSIFIED
DATE 5/23/85 BY SP2MGT/BR

b7C

Your attention is directed to the report of Special Agent [redacted] dated October 9, 1942 at Pittsburgh, Pa., in which information is set out indicating that Subject was inducted into the United States Army on August 25, 1942. On December 6, 1945 the records of Local Board #5, Pittsburgh, Pa. were again reviewed relative to the Subject and reflected that the Subject is still in the armed forces. A letter is being directed to the Office of Military Intelligence, Pittsburgh, Pa., requesting that this office be notified when the Subject is no longer in the service. (u)

RECORDED

In compliance with Bureau instructions, the security index ~~and relative to the~~ Subject is being removed from the security index box and placed in the Subject's investigative file. (u)

100-57876-1
JAN 7 1946PAT:BKS
100-672-

1946

25

Office Memorandum • UNITED STATES GOVERNMENT

TO : DIRECTOR, FBI

DATE: April 29, 1946

FROM : SAC, NEW YORK

SUBJECT: LLOYD LOUIS BROWN
INTERNAL SECURITY - C

b7C

Reference is made to the report of Special Agent dated December 6, 1941, at Pittsburgh in the above captioned case. (u)

Peoples Voice for April 13, 1946, page 5, column 3, carried a photograph of LLOYD BROWN with a caption saying that he had assumed a position of managing editor of NEW MASSES magazine; that he served for three years as an Army Air Force Sergeant, and prior to his Army service he was correspondent for the Labor Press, and an organizer for the United Hotel Workers of America, CIO. Peoples Voice is a Negro publication in New York City. It appears that LLOYD BROWN is not located in New York City. (u)

For the information of the Bureau and Pittsburgh, the NEW MASSES magazine recently underwent a re-organization with considerable shuffling of personnel. LLOYD BROWN appears to be one of the new members of the magazine's personnel. (u)

Since Pittsburgh appears to be the office of origin in this case, it is requested that the Pittsburgh Office notify the New York Office of any forwarding residence address that they may have for BROWN, or any information which will assist this office in ascertaining his present residence address. (u)

ALL INFORMATION CONTAINED
HEREIN IS UNCLASSIFIED
DATE 5/23/83 BY SP2MUR

cc: Pittsburgh

RECORDED

EX - 23

100-17876-10
30 FEB 1 1946

RSG:CEM
100-24616

b7C

52 MAY 7 1946

FEDERAL BUREAU OF INVESTIGATION

Form No. 1

THIS CASE ORIGINATED AT **PITTSBURGH, PENNSYLVANIA**

NY FILE NO. **100-24616**

MCG/KD

REPORT MADE AT NEW YORK, NY	DATE WHEN MADE 2/25/47	PERIOD FOR WHICH MADE 1/20/47	REPORT MADE BY <div style="border: 1px solid black; width: 100px; height: 20px;"></div> b7C
TITLE LLOYD LOUIS BROWN			CHARACTER OF CASE SECURITY MATTER - C

SYNOPSIS OF FACTS:

LLOYD LOUIS BROWN presently resides at 408 West 130th Street, New York City and is employed as Managing Editor of the "New Masses" magazine. BROWN is active in the United Veterans for Equality, and is a member of the Queens County Communist Party. (u)

DECLASSIFIED BY SP2 MAL/BR ON 5-23-03

- P - Not a FOIPA Deletion

NO
MAR 17 1947
STATISTICS

REFERENCES:

Pittsburgh File #100-672.
Letter from the Pittsburgh Field Division dated December 31, 1946. (u)

DETAILS:

At New York City:

By means of a pretext, it was ascertained from b7C
b7D

that the subject presently resides with his family at 408 West 130th Street, New York City. He is employed as the Managing Editor of the Communist magazine "New Masses", which is located at 104 East 9th Street, New York City. (u)

Confidential Informant confirmed the fact that LLOYD BROWN is presently the Managing Editor of the "New Masses" magazine. Informant also stated that BROWN was formerly a member of the Youth Communist magazine and is presently an officer of the United Veterans for Equality. (u) b2
b7D

In the Daily Worker under date of January 28, 1946, there appeared an article concerning LLOYD LOUIS BROWN. (u)

APPROVED AND FORWARDED: Edward Scheidt SPECIAL AGENT IN CHARGE

ENCLOSURE DO NOT WRITE IN THESE SPACES

- COPIES OF THIS REPORT
- 5 - Bureau
 - 2 - Pittsburgh (u)
 - 3 - New York
- COPY IN FILE

100-57876-11
F I
34 FEB 1947

b7C

RECORDED & INDEXED
217 EX-72

COPIES DESTROYED 4/5/58

CHAP. 3

NY 100-24616

which is believed to be identical with the subject of this case. It was reported that BROWN is a negro ex-serviceman and represented the "United Veterans for Equality" and pledged his and his buddies fight for a people's victory on the home front. It was reported that this statement by BROWN was made at a mass meeting at the Golden Gate Ballroom, 142nd Street and Lenox Avenue, on the occasion of the "Smash the Filibuster" Rally. Other principal speakers at this event were VITO MARCANTONIO and Congressman ADAM CLAYTON POWELL. (u)

In the Daily Worker of April 6, 1946, the following article concerning LLOYD LOUIS BROWN appeared: (u)

Parts of this article are quoted below: (u)

"The Readers Digest can bump along its evil way isolated in Westchester and the Luce publications can come out of a penthouse but a Marxist magazine like 'New Masses' can only come out of the people." "That's why in changing to new format and a broader cultural content, New Masses is inviting its readers and friends to a conference to discuss the change. It was announced that the conference was to be held at the Paramount Restaurant, 138 West 43 Street, on April 13 at 2 P.M. This article continued by stating that the New Masses magazine would follow a Marxian policy and would attempt to bring to the people information prepared by the working class. It was announced that LLOYD LOUIS BROWN had been appointed as a new editor to the staff of New Masses. (u)

In the daily worker of April 9, 1946, there appeared a half page advertisement announcing that 300 Communist Party clubs would hold a special meeting that week. The following headline appeared in this advertisement: "Hear: Outstanding Leaders of the Communist Party Speak On All Branches on 'The Struggle for Peace and Building the Communist Party'." (u)

LLOYD LOUIS BROWN was listed as a speaker for this event from New York County. (u)

NY 100-24616

On October 5, 1946, there appeared in the "People's Voice" an article which carried the following headline: "Writers Discuss Anti-Fascist". It was announced that Contemporary Writers had announced that week the theme for the general meeting and forum to be given at Malih Studios, 315 West 42nd Street at 8:30 P.M. (the date was omitted in the article but it was believed to be October 3, 1946). The theme for the forum was to be "The Negro in American Literature." LLOYD LOUIS BROWN was listed as a speaker. A brief summary concerning BROWN stated that he was Editor of the New Masses magazine and was a World War II veteran, having travelled widely in Europe as correspondent for Labor Press. (u)

In the Daily Worker on September 28, 1946, there appeared an advertisement announcing that LLOYD BROWN, Managing Editor on New Masses, would be speaker at the first Allerton Section, C.P. series of forums. It was announced that BROWN would speak on "New People's Democracy in Eastern Europe". The date of the forum was not given but was listed as Sunday at 8 P.M., the place was 2700 Olinville Avenue, Bronx, New York, and the admission was 25¢. (u)

Confidential Informant [] advised that LLOYD BROWN was a member of the Communist Party at Queens County and the headquarters of this group is located at 46-14 Queens Boulevard, Long Island City. (u)

b2
b7D

- P E N D I N G -

NY 100-24616

UNDEVELOPED LEAD

NEW YORK FIELD DIVISION

At New York, N.Y.

Will follow and report the Communist activities of
the subject in this city. (u)

NY 100-24616

~~CONFIDENTIAL~~
CONFIDENTIAL - INFORMANT

b7C

The confidential informant mentioned in the report of Special Agent [redacted] dated February 25, 1947, at New York, N.Y. is as follows:

[redacted]

b2
b7C
b7D

A trash cover on the headquarters of the Queens County Communist Party, 4614 Queens Boulevard, Long Island City made available by Confidential Informant [redacted] to Special Agent [redacted]

CONF. INFT.

(u)
↑
↓

~~CONFIDENTIAL~~

Office Memorandum • UNITED STATES GOVERNMENT

TO : Director, FBI

DATE: February 25, 1947

FROM : SAC, New York

SUBJECT: LLOYD LOUIS BROWN
SECURITY MATTER - C

b7C

Reference is made to the enclosed pending report of Special Agent [redacted] dated February 25, 1947 at New York in the above captioned case. (u)

It is requested that New York be made office of origin in this case in view of BROWN's present residence and employment in this city. (u)

Enclosures - 5

cc - Pittsburgh (encls.)

G. I. R. -5

T
5 ENCL
EX - 72
FJS:KD
100-24616

REC.
&
INDEXED

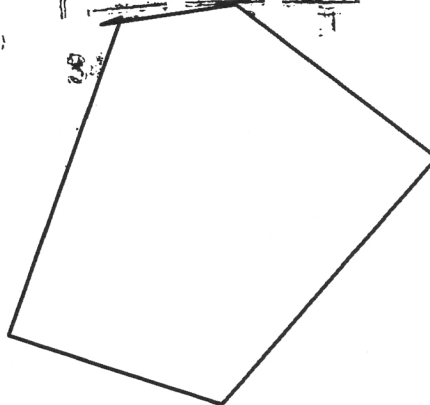

b7C

ALL INFORMATION CONTAINED
HEREIN IS UNCLASSIFIED
DATE 5-23-03 BY SP2 MLT/ABR

Let Sac 2/9
cc
3/20/47
Kerr (u)

mw

March 11, 1947

URGENT
CODE UNDELETED

PITTSBURGH

RE LLOYD LOUIS BROWN, WA, IS DASH C. YOUR FILE ONE HUNDRED DASH SIX SEVEN TWO.
SUBMIT WITHIN TWO WEEKS SUMMARY REPORT SETTING FORTH BY WITNESSES LEGALLY
ADMISSIBLE EVIDENCE TENDING TO PROVE SUBJECT'S MEMBERSHIP IN OR IS AFFILIATED
WITH CP AND KNOWLEDGE OF REVOLUTIONARY AIMS AND PURPOSES OF CP. CONFIDENTIAL
INFORMANTS OR SOURCES SHOULD BE APPROPRIATELY PROTECTED BY SYMBOL. SUBMIT
REPORT UNDER COVER LETTER CAPTIONED "CP, USA DASH BRIEF, IS DASH C UNQUOTE (u)

HOOVER

100-57876

ALL INFORMATION CONTAINED
HEREIN IS UNCLASSIFIED
DATE 5/29/03 BY 60270 BCE/MUK/BER

MAR 11 1947



RECEIVED

MAR 11 7 03 PM '47

RECORDED



57876-1

8:02 PM

Per B

b7C

58 MAR 11 1947

EXAMIN
REFER TO
JAMES HUNN!

- Tolson
- E. A. Tamm
- Clegg
- Glavin
- Ladd
- Nichols
- Rosen
- Tracy
- Carson
- Egan
- Gurnea
- Harbo
- Hendon
- Pennington
- Quinn Tamm
- Nease
- Gandy

March 20, 1947

Special Agent in Charge
New York, New York

Re: **LLOYD LOUIS BROWN;**
SECURITY MATTER - C

Dear Sir:

Reference is made to your letter of February 25, 1947.
requesting that the division of origin be changed in the above en-
titled case. (u)

You are hereby authorized to designate New York, New York
as the division of origin. (u)

Upon receipt of this communication, you are requested to
carefully check your file and make certain that the new division of
origin has all serials in the case containing important data. (u)

Very truly yours,

J. E. Hoover

John Edgar Hoover
Director

b7C

CC: SAG, Pittsburgh (u)
100-57875
HWS:vj

ALL INFORMATION CONTAINED
HEREIN IS UNCLASSIFIED
DATE 7/79 BY

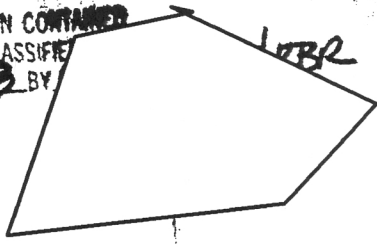

RECORDED

EX-38

COMMUNICATIONS SECTION
RECEIVED
MAR 20 1947

- Mr. Tolson _____
- Mr. E. A. Tamm _____
- Mr. Clegg _____
- Mr. Glavin _____
- Mr. Ladd _____
- Mr. Nichols _____
- Mr. Rosen _____
- Mr. Tracy _____
- Mr. Carson _____
- Mr. Egan _____
- Mr. Gurnea _____
- Mr. Harbo _____
- Mr. Hendon _____
- Mr. Pennington _____
- Mr. Quinn Tamm _____
- Mr. Nease _____
- Miss Gandy _____

60 MAR 24 1947

26

Office Memorandum • UNITED STATES GOVERNMENT

TO : Director, FBI

DATE: 3/24/47

FROM : SAC, Pittsburgh

SUBJECT: COMMUNIST PARTY - BRIEF
INTERNAL SECURITY - C
Bureau File #100-5-74

ALL INFORMATION CONTAINED
HEREIN IS UNCLASSIFIED
DATE 5/27/03 BY 60290/BCE/MCT/KSP/K

G. I. [unclear]
[unclear]

1-3

t
Kt

b7C

Reference is made to a teletype from the Bureau dated March 11, 1947 entitled, "LLOYD LOUIS BROWN, was, Internal Security," Bureau File No. ~~100-10773~~, requesting this office to submit a summary report regarding the subject. Attached is the report of Special Agent [redacted] dated March 24, 1947, setting forth all admissible evidence tending to prove the subject's membership in and affiliation with the Communist Party and his knowledge of the aims and purposes of the Communist Party. (u)

Not included in the summary report is the fact that this office is in possession of the 1937 Year Book of the Young Communist League of America, which mentions on page 26, under the heading, National Committee, the following: (u)

"Lloyd Brown, State Secretary, Young Communist League, Western Pennsylvania, hails from St. Paul...joined YCL in 1929...was active in Cleveland, Youngstown, Connecticut, New Jersey, New York and all other points east." (u)

This has been omitted from the summary report since it has not been identified for introduction as evidence and cannot be used unless judicial notice may be taken thereof. (u) Referral/Direct

~~DEFERRED~~

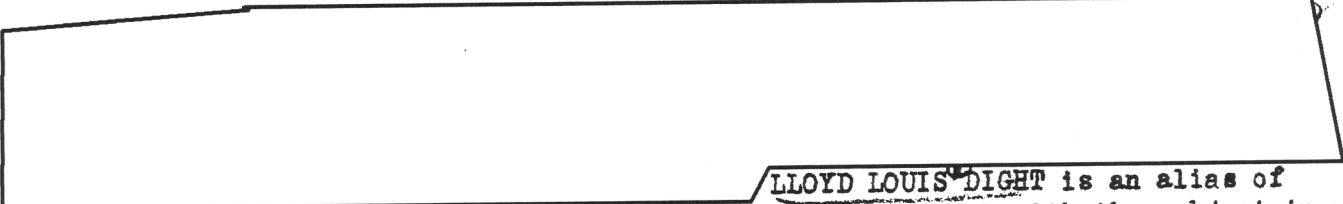

LLOYD LOUIS DIGHT is an alias of the subject but it has never been shown that he is identical with the subject in this case. However, according to the records of Local Board No. 5, Herron Hill High School, 3800 Center Ave., as produced by Chief Clerk [redacted] the subject stated in his questionnaire, filed with that board on June 17, 1941, that he was also known as LLOYD LOUIS DIGHT.

b7C

Inasmuch as the subject is now and has been for some time residing in New York City, two copies of the summary report are being forwarded to the New York Field Division for their information. (u)

ENCLOSURE

RBS:KRW
100-672
cc - 100-8587
Enclosures

~~COPIES DESTROYED~~

1 cc of [unclear] 57876-14
[unclear] 1647
[unclear] 32

Enclosures detached to be filed in main file on Lloyd Louis Brown

(u)
(u)

b7C

5-7092

60 APR 2 1947 4/216

Form No. 8

THIS CASE ORIGINATED AT **PITTSBURGH**

FILE No. 100-672

1-3
1-10

REPORT MADE AT: Pittsburgh, Pa.	DATE WHEN MADE: 3/22/47	PERIOD FOR WHICH MADE: 3/13, 14, 15, 18, 19/47	REPORT MADE BY: <div style="border: 1px solid black; width: 100px; height: 15px;"></div>
TITLE: LLOYD LOUIS BROWN, was L. L. Brown, Lloyd Louis <i>Light</i>		CHARACTER OF CASE: INTERNAL SECURITY - C b7C	

SUMMARY REPORT

This report is submitted per Bureau teletype to this office dated March 11, 1947 and sets forth admissible evidence tending to prove: (u)

1. The subject's membership in and affiliation with the Communist Party. (u)
2. The subject's knowledge of the aims and purposes of the Communist Party. (u)

LLOYD LOUIS BROWN, colored, was born April 3, 1913 at St. Paul, Minnesota and married

[Redacted]

(u)
File shows

[Redacted]

(u)

b7C

COPIES DESTROYED 1/21/51

5/28/43 SPZ mth

cc - [Redacted] 3/31/47

DO NOT WRITE IN THESE SPACES

APPROVED AND FORWARDED: J. A. Fletcher	SPECIAL AGENT IN CHARGE	100-672-16	RECORDED AND INDEXED: RECORDED
COPIES OF THIS REPORT FURNISHED TO: 5 - Bureau 2 - New York 3 - Pittsburgh (cc - 100-8587) KRW		BUREAU OF INVESTIGATION DEPARTMENT OF JUSTICE	CHECKED OFF: EX-37
[Redacted]		FILE	b7C

I. SUBJECT'S MEMBERSHIP IN AND AFFILIATION WITH THE COMMUNIST PARTY

b2

Confidential Informant [] can testify that:

b7D

1. Subject's name was sent out by the Communist Party, District #5 Headquarters in 1938 to Communist Party Section Organizers as a speaker for use at section functions.
2. LLOYD LOUIS BROWN was active in the Young Communist League, Pittsburgh, Pa.
3. Subject was a member of the District #5 Committee of the Communist Party in March 1941.
4. The subject was in the Communist Party Office, 305 Seventh Avenue, Pittsburgh on October 17, 1941.
5. On [] the subject attended a [] Party at 1800 Center Avenue, Pittsburgh [] (21)
6. Subject attended a welcome party held under the auspices of the Communist Party at 1800 Center Ave., Pittsburgh, Pa. for []
7. A [] conference of the leaders of the Communist Party of Western Pennsylvania was held at 1800 Center Ave., Pittsburgh, Pa. from [] to [] on [] which the subject attended.
8. On May 2, 1942 the subject attended a May Day celebration and party held at the Carnegie Hall, North Side, Pittsburgh, Pa. under the auspices of the Communist Party. [] Communist Party District [] presided and [] Communist Party Pennsylvania State [] was principal speaker.

b7C
b7D

b7D

b7C

Special Agent [] can corroborate subject's attendance on this date.

Special Agent [] can testify that:

1. The subject was recognized as attending on November 8, 1941 at 805 James

Street, Pittsburgh, Pa. the 24th anniversary celebration of the Russian October Revolution. The principal speaker was [redacted]

[redacted] said the Communist Party should get labor to aid in support of Russia and England and to free [redacted] from jail.

- b7C
2. On January 25, 1942 the subject attended a Lenin Memorial Meeting sponsored by the Communist Party of Pennsylvania held at the Carnegie Hall, North Side, Pittsburgh, Pa. Guests of honor were [redacted]

[redacted] of the Communist Party, Western Pennsylvania presided and [redacted] Michigan State [redacted] of the Communist Party, was the main speaker.

3. The subject attended a mass meeting of the Communist Party held May 2, 1942 in the Carnegie Hall, North Side, Pittsburgh, Pa., at which "The Young Communist Review" was sold. [redacted] Communist Party, presided and [redacted] Communist Party, was the main speaker. (u)

b2
b7D

Confidential Informant [redacted] can corroborate subject's attendance at this meeting.

4. On May 26, 1942 the subject was seen to attend a Communist Party Meeting at 1800 Center Ave., Pittsburgh, Pa.
5. Subject attended an Independence Day Rally on July 4, 1942 at Linden Grove, Castle Shannon, Pa. [redacted] was the main speaker at the rally, which was held under the auspices of the "Labor Press Committee" and the Communist Party as such was not mentioned in circulars advertising the rally. [redacted] said at the rally, "It is up to you comrades to bolster the membership of the Communist Party in Western Pennsylvania." b7C

[redacted] (home address - [redacted]), Clerk of Courts, Allegheny County Court House, 436 Grant St., Pittsburgh, Pa. can testify and introduce records to the effect that:

1. An Allegheny County Grand Jury on July 5, 1940 returned true bills of indictment against the subject charging:
 - A. In Indictment #519 conspiracy to prevent a free, fair and legal election on November 5, 1940 in the national and state elections by agreeing and conspiring to fraudulently secure nominations of persons as candidates for the Communist Party.
 - B. In indictments #596 and 597:
 1. Perjury (u)

2. Making false statements in affidavit in violation of the state of Pennsylvania Election Code of 1937.

2. Verdicts of guilty were returned October 30, 1940 in connection with the trial of the subject.

3. As a result of his convictions subject was sentenced on March 19, 1941 as follows:

A. Indictment #519 - four months in jail - \$200. fine.

B. Indictment #596 - four months in jail concurrent with the sentence under #519.

C. Indictment #597 suspended sentence by reason of sentence under Indictment #519.

Confidential Informant can testify that: b2
b7D

1. Subject is a member of the Communist Party, Queens County, 46-14 Queens Boulevard, Long Island City, New York.

II SUBJECT'S KNOWLEDGE OF AIMS AND PURPOSES OF COMMUNIST PARTY

None

The following is criminal record of the subject, who has FBI #2049998:

<u>CONTRIBUTOR OF FINGERPRINTS</u>	<u>NAME AND NUMBER</u>	<u>ARRESTED OR RECEIVED</u>	<u>CHARGE</u>	<u>DISPOSITION</u>
PD, Pgh., Pa.	Lloyd Brown #33301	1-21-37	vag; traffic viol.	Ct 1 disch; Ct 2 10 days jail
Alleg. Co. Det. Bu., Pgh., Pa.	Lloyd Louis Brown #11708	7-8-40	perjury	4 mo. in jail \$200 fine

Confidential Informant [] is Confidential Informant [] whose identity is known to the Bureau. (u)

b2
b7D

Confidential Informant [] is New York Confidential Informant [] whose identity is known to the Bureau. (u)

WAR DEPARTMENT
WAR DEPARTMENT GENERAL STAFF
INTELLIGENCE DIVISION
WASHINGTON, D. C.

b7C

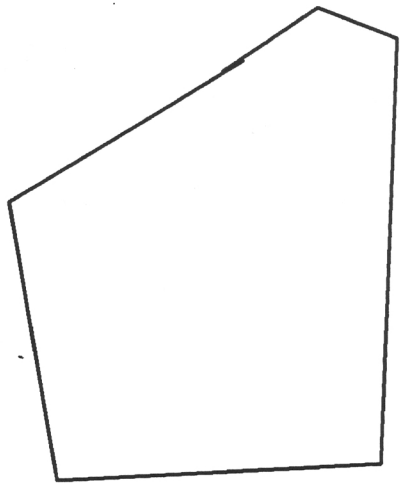

MEMORANDUM FOR THE FEDERAL BUREAU OF INVESTIGATION:

*Active
Pittsburgh
4-11-47*

SUBJECT: BROWN, Lloyd Lewis
Alias DIGHT, Lloyd Louis
ASN 33287993
F.B.I. File No. Bureau File No. Not Available
Pittsburg F.B.I. File No. 100-672

1. The above captioned individual, formerly a member of U.S. Army, separated from service in accordance with demobilization procedures and reverted to inactive status on 4 December 1945 at _____.
2. SUBJECT is listed in our files as a Communist.
3. Upon separation from the Army he gave as his civilian mailing address: 420th West 130th St., New York, New York.
4. Change of SUBJECT's status is being forwarded as a matter of possible interest to the Bureau.
5. Request this Division be furnished any information concerning SUBJECT's future activities which are believed to be of interest to us, should he attempt to re-enter the armed forces or secure employment with the War department.
6. Request your reply be addressed to Chief, Operations Branch, Security Group, Intelligence Division, WDGS, with inner envelope bearing notation to be opened by addresses only.

*Rec'd from war
dept 4/17/47
JPK*

ALL THE INFORMATION CONTAINED
HEREIN IS UNCLASSIFIED
DATE 12/1/03 BY 60290 BLS/KBR

RECORDED
SERIALIZED

100-57876-45
F B I
37 MAY 17 1947

3-67

b7C

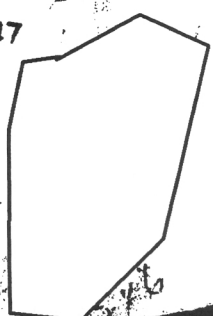

100-57876

RECORDED SAC, Pittsburgh

Director, FBI

May 9, 1947

LLOYD LIND B... with aliases
SECURITY MATTER - C
New file #100-672

Since the New York Office is the Office of Origin at the present time and the subject in the past has been the subject of a Security Index card in your Office, you are requested to forward to the Bureau immediately Form FD-128, in order that the Security Index card at the Bureau may be revised.

100-57876
CC: New York

(u)

2-
2-6

ALL INFORMATION CONTAINED
HEREIN IS UNCLASSIFIED
DATE 5/27/03 BY 60290/BEE/MCT/BR

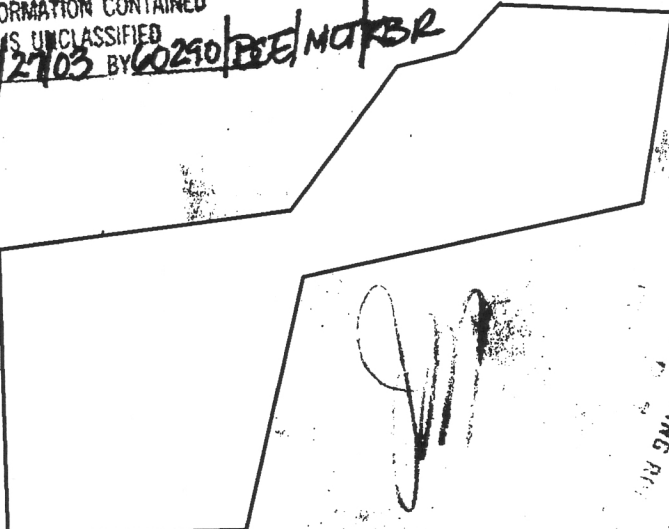

b7C

JEM:bb *bb*

COMMUNICATIONS SECTION
MAILED 5
★ MAY 10 1947 P.M.
FEDERAL BUREAU OF INVESTIGATION
U. S. DEPARTMENT OF JUSTICE

SON
A. Tamm
EC
vin
C
DLS
sh
CY
SON
R
JGA
DO

RECEIVED READING ROOM
MAY 10 9 51 AM '47

MAY 2 1947